

Mosaic™ Equipotential socket

Cat. Nos: 0 787 00 - 0 787 60L - 7 759 93

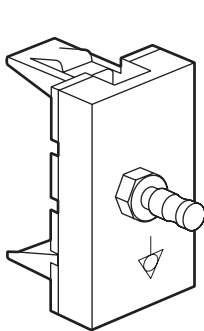

0 787 00

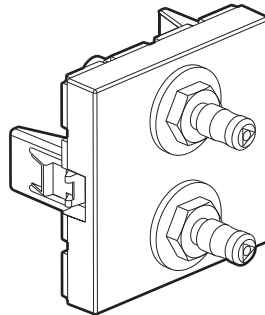

0 787 60L

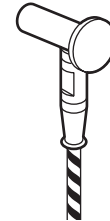

7 759 93

1. USE

Equalises the voltages of all the conductive elements and all the exposed conductive parts, as well as limiting the contact voltage to a value that is not dangerous for people.

For use in hospital environments to help protect sensitive equipment from interference.

Socket:

This product is made of silver-ion based antimicrobial* material. This technology eliminates bacteria, fungi and viruses without creating any immunisation or resistance effects (physical, rather than chemical, destruction).

Particularly suitable for healthcare establishments (hospitals, clinics, nursing homes, laboratories, waiting rooms, etc.) and more generally for areas subject to hygiene restrictions (industrial, shared and restaurant kitchens, waste, etc.).

This product offers an additional way of ensuring the non-proliferation of bacteria, fungi and viruses without interfering with cleaning protocols

2. RANGE

Description	Cat. Nos
Equipotential socket supplied with metal plate contact, washers, nut and pin - White antimicrobial* - 1 module	0 787 00
Equipotential socket supplied with metal plate contact, washers, nut and pin - White antimicrobial* - 2 modules	0 787 60L
Equipotential connection plug	7 759 93

3. PREPARATION

Mounting

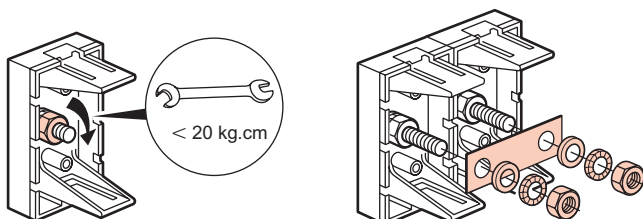
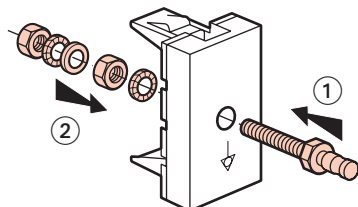

3. PREPARATION (continued)

Earth connection

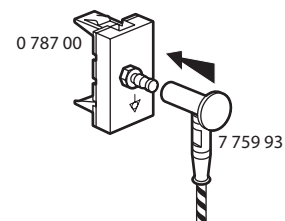

4. DIMENSIONS (mm)

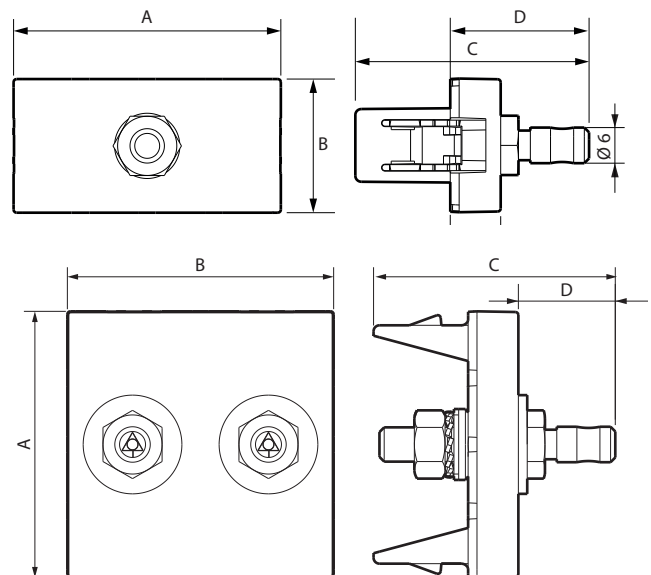

Cat. No	A	B	C	D
0 787 00	45	22.5	39.5	23.5
0 787 60L	45	45	41	16.5

5. CONNEXION

■ 5.1 Equipotential socket Cat. No 0 787 00

Capacity: max. 6 mm²

■ 5.2 Equipotential connection plug Cat. No 7 759 93

Use crimping pliers

Flexible cable compatible, capacity: min. 4 mm² - max. 6 mm²

Stripping length: 15 mm

6. TECHNICAL CHARACTERISTICS

■ 6.1 Mechanical characteristics

Protection against solid bodies and liquids: IP 41

Protection against impacts: IK 04

■ 6.2 Material characteristics

Socket: ABS White RAL 9003 + antimicrobial* surface treatment

Self-extinguishing: 650°C/30 s

■ 6.3 Climate characteristics

Storage temperature: - 10°C to + 70°C

Usage temperature: - 5°C to + 35°C

7. CARE

Clean the surface with a cloth.

Do not use acetone, tar-removing cleaning agents or trichloroethylene.

■ 7.1 Resistance to cleaning products

Hexane (EN 60669-1), methylated spirit, soapy water, diluted ammonia, bleach diluted to 10%, window-cleaning products, pre-impregnated wipes.

■ 7.2 Resistance to hospital grade cleaning products

Anios, Surfianos, Bactily sine, diluted hydrogen peroxide (35%)

Caution: Always test before using other special cleaning products.

8. STANDARDS AND APPROVALS

Conforms to standards DIN 42801 and IEC 60364-7710.

* Contains silver ions that limit the development of bacteria on the surface.